

**HW SERIES
HOT WATER REELS****APPLICATION**

Specially designed for hot water wash down applications in kitchens and food prep areas.

Perfect for use in food processing areas - the vented case design allows the reel to be hygienically cleaned as required and allows for adequate air flow.

Available with or without a heavy duty, fully insulated washdown gun.

For accessories, guns and nozzles, see page 152.

HOSE TYPE Nitrile blended PVC

MEDIA Hot water

MINIMUM TEMP -30°C

MAXIMUM TEMP 85°C

MAX PSI 225*

FITTING TYPE BSP**

WEIGHT 12kg***

Standard swivel configuration is brass; 316 stainless steel is available as an optional extra.

*Maximum working pressure of the hose is rated at 225psi @ 23°C, operating temperature 85°C @ 120psi.

**NPT, JIC, JIS and Metric threads are available on request.

***HW1015 weighs 11kg.







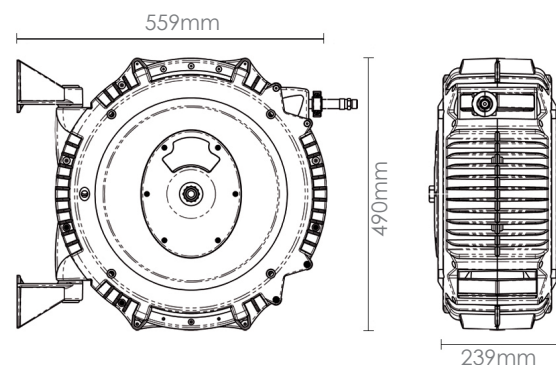

HW1215

HWG1215

FEATURES

HWG1215
SHOWN ABOVE

**DIMENSIONS****HW SERIES**

Model	Hose ID	Hose Length	Max PSI	Inlet Fitting	Outlet Fitting
 HW1015	10mm	15m	240	3/8" BSPF	3/8" BSPM
 HW1020	10mm	20m	240	3/8" BSPF	3/8" BSPM
 HW1215	12mm	15m	240	1/2" BSPF	1/2" BSPM
 HWG1015	10mm	15m	240	3/8" BSPF	Heavy Duty Washdown Gun
 HWG1020	10mm	20m	240	3/8" BSPF	Heavy Duty Washdown Gun
 HWG1215	12mm	15m	240	1/2" BSPF	Heavy Duty Washdown Gun

 = Quick Ship Item, see inside back cover for more information.